

User's Manual

NOCPIX
LUMI SERIES

Thermal Imaging Monocular



WARNING! ITAR REQUIREMENTS

These products may be subject to export and foreign trade control laws of the United States and may not be exported without prior approval of the U.S. Department of State. Learn more at irayusa.com/ITAR.

FCC Statement

FCC ID: 2BHFB-LUMI-00

This device complies with part 15 of the FCC Rules. Operation is subject to the following two conditions: (1) This device may not cause harmful interference, and (2) this device must accept any interference received, including interference that may cause undesired operation.

CAUTION: Changes or modifications not expressly approved by IRayUSA could void the user's authority to operate the equipment.

NOTE: This equipment has been tested and found to comply with the limits for a Class B digital device, pursuant to part 15 of the FCC Rules. These limits are designed to provide reasonable protection against harmful interference in a residential installation. This equipment generates, uses and can radiate radio frequency energy and, if not installed and used in accordance with the instructions, may cause harmful interference to radio communications. However, there is no guarantee that interference will not occur in a particular installation. If this equipment does cause harmful interference to radio or television reception, which can be determined by turning the equipment off and on, the user is encouraged to try to correct the interference by one or more of the following measures:

- Reorient or relocate the receiving antenna.
- Increase the separation between the equipment and receiver.
- Connect the equipment into an outlet on a circuit different from that to which the receiver is connected.
- Consult the dealer or an experienced radio/TV technician for help.

This device was tested for typical body-supported operations and use. To comply with RF exposure requirements, a minimum separation distance of 0.5cm must be maintained between the user's body and the handset, including the antenna. Third-party belt-clips, holsters, and similar accessories used by this device should not contain any metallic components. Body accessories that do not meet these requirements may not comply with RF exposure requirements and should be avoided. Use only the supplied or an approved antenna.

WARNING: CHOKING HAZARD

Children under 3 years old can choke or suffocate on small parts of this product. This product is not a toy; keep out of reach of children.

Table of Contents

1.	Overview	2
2.	Features	2
3.	Tech Specs	3
4.	Accessories	4
5.	Components and Controls	5
6.	Description of Control Buttons and Shortcuts	6
7.	Quick Start Guide	7
8.	Charging the Batteries	9
9.	Installing a Battery	10
10.	Removing the Battery	11
11.	Battery Safety Warnings	11
12.	External Power Supply	12
13.	Operating Instructions	13
14.	Non-Uniformity Correction	18
15.	Photography and Video Recording	19
16.	Accessing the Internal Memory	21
17.	Using the NOCPIX App	21
18.	Digital Zoom	22
19.	Picture in Picture	22
20.	Ultra-Clear Mode	23
21.	Main Menu Options and Descriptions	23
22.	Warranty	31
23.	Basic Inspection	32
24.	Basic Maintenance	32
25.	General Troubleshooting	33
26.	Notes	36

1. Overview

The all-new LUMI series of handheld thermal monoculars (L35 and H35) features a high-quality thermal sensor paired with a 1024x768 AMOLED display. Available models offer either a 4x base magnification (L35) for identifying targets at greater distances or a 2.5x base magnification (H35) for a wider field of view. Advanced image processing algorithms and a ≤ 18 mK NETD thermal sensitivity rating provide sharp, high-contrast images. As a powerful tool for scouting and scanning, LUMI was designed to be as compact and ergonomic as possible while still offering impressive image detail and clarity. LUMI weighs less than 12 ounces and easily fits in the palm of the hand, a pocket, or the included MOLLE-compatible case. LUMI includes two interchangeable 18650 rechargeable batteries, each providing over four hours of run time. LUMI comes with 32 GB of internal media storage for recording photos and videos (with audio).

2. Features

- Reality+ technology
- 12 μ m high-performance thermal detector
- ≤ 18 mK sensitivity
- Digital zoom from 1.0x–4.0x
- Polymer housing with rubber overmold
- Includes two rechargeable 18650 batteries
- Maximum detection range 1750 yards
- 1024x768 AMOLED display
- High frame frequency: 50Hz
- Built-in 32 GB storage to support image capture and video recording
- Built-in Wi-Fi module
- Mobile device App compatible
- Picture in Picture (PIP)
- Ultra-Clear mode
- Multiple color palettes
- Compact and lightweight
- Warm and cool image-hue options
- User-friendly interface

3. Tech Specs

	LUMI L35	LUMI H35
Sensor		
Resolution	384x288	640x512
Pixel Size	12 μ m	
Frame Rate	50hz	
Sensor Sensitivity	≤ 18 mK	
Image Processing	Reality+	
Core	Nocpix 384	Nocpix 640
Optics		
Objective Lens	35 mm f/0.9	
Magnification	4x	2.5x
Digital Zoom	4x	8x
Field of View	7.5° x 5.7°	12.5° x 9.4°
Detection Range	1750 Yards	
Display Type	AMOLED	
Display Resolution	1024x768	
Color Palettes	White Hot, Black Hot, Red Hot, Color, Crimson, Viridian, Violet	
P.I.P.	Yes	
Rangefinder	None	
Eye Relief	25 mm	
Diopter Range	-5 to +5	
Electronics		
Onboard Recording	Video and Image	
Onboard Storage	32 GB	
Wireless Connectivity	Image and Video via App.	
Data/Power Connector	USB-C	
Power Supply	USB-C External, 18650 Batteries x2 (4+ Hours Each)	
Start Up Time	<10 Seconds, Instant from Standby	
Physical		
Size	5.63" x 1.85" x 2.91"	
Weight	11.82 Oz	12.17 Oz
Environmental/Warranty		
Warranty	5 Years	
Housing Material	Polymer with Rubber Overmold	
Ingress Protection	IP67	
Operation Temperature	-4°F~122°F	

4. Accessories

The LUMI Series thermal imaging monocular ships with everything you need to get out and hunt.

- 19mm or 35mm Objective Lens Cap
- 18650 Batteries x2
- 18650 Battery Charger
- USB-C Cable
- Carrying Bag and Straps
- Lens Cloth
- User Manual



Various replacement accessories are available for purchase. Contact us at 800-769-7125 or irayusa.com/support.

5. Components and Controls

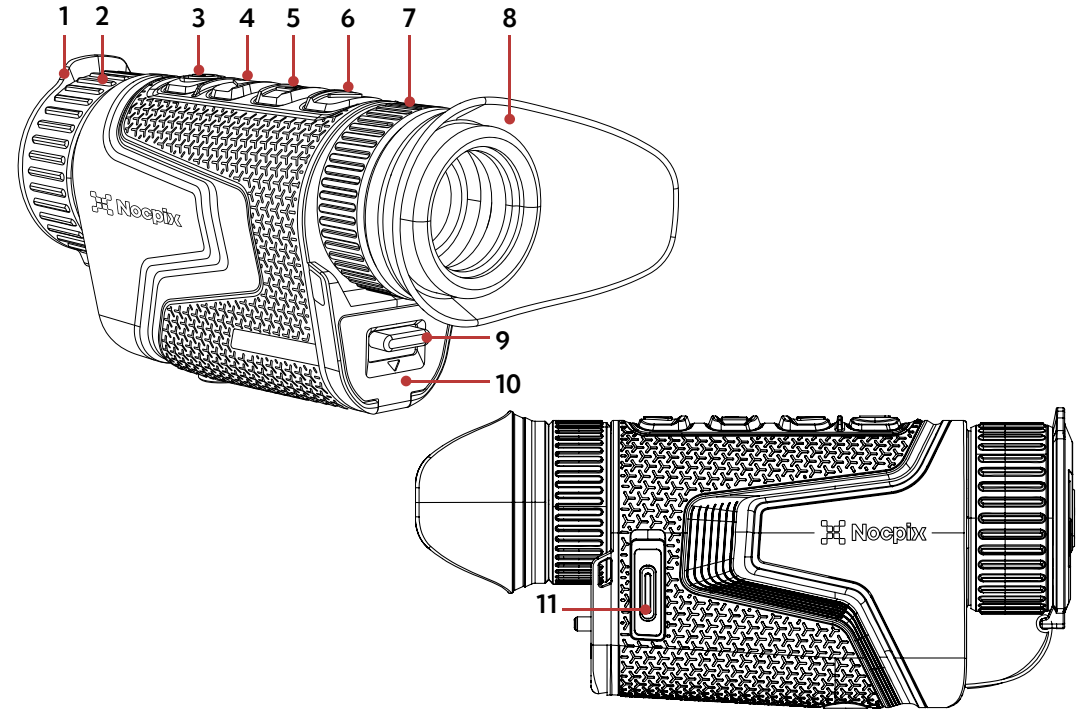



- | | | | |
|---|---------------------------|----|------------------------------------|
| 1 | Objective Lens Cap | 7 | Eyepiece / Diopter Adjustment Ring |
| 2 | Objective Lens Focus Knob | 8 | Eyeguard |
| 3 | Power Button | 9 | Battery Release Button |
| 4 | Up Button | 10 | Battery Compartment Cover |
| 5 | Menu Button | 11 | USB-C Port |
| 6 | Down Button | | |

6. Description of Control Buttons and Shortcuts

Power Button 		
Current Screen, Menu, or Device Status	Short Press	Long Press
Device off	---	Power on the device
Home screen	Enter standby mode	Power off the device
Standby mode	Exit standby	---
Main menu	Return to the previous menu without saving changes	---

Up Button 		
Current Screen / Menu	Short Press	Long Press
Home screen	Adjust the digital zoom level	Turn on/off the PIP window
Main menu / quick menu	Move the cursor up	---

Up Button  + Down Button 		
Current Screen / Menu	Short Press	Long Press
Home screen	Manually perform a shuttered non-uniformity correction	Manually perform a shutterless non-uniformity correction

Menu Button 		
Current Screen / Menu	Short Press	Long Press
Home screen	Enter the quick menu	Enter the main menu
Main menu	Change menu options; enter submenu; or confirm submenu changes and return to previous menu	Save and return to the home screen
Quick menu	Toggle through the menu options	Exit the quick menu

Down Button 		
Current Screen / Menu	Short Press	Long Press
Home screen	Take a photo	Start / stop recording video
Main menu / quick menu	Move the cursor down	---

7. Quick Start Guide

Step 1: Prepare to Use the LUMI

1. Compare the box contents to the accessories list and examine each for any shipping damage. See **Accessories** on page 4.
2. Check the lens to ensure there are no smudges or dirt present. Clean with the included lens cloth, if necessary.
3. Charge the batteries (12). See **Charging the Batteries** on page 9.

Step 2: Turn On the LUMI

1. Open the objective lens cap (1).
2. Long press the **Power  Button** for 3 seconds to power on the LUMI.

3. Rotate the eyepiece diopter adjustment ring (7) until the interface icons are clear.

WARNING: Do not point the objective lens toward intense energy sources, such as the sun. This may render the electronic components inoperative. The warranty does not cover damage caused by improper operation.

Step 3: Adjust Settings in the Quick Menu

Short press the **Menu (M) Button** to enter the quick menu to adjust the following settings (see **Using the Quick Menu** on page 16):

1. Set the color palette to white hot, black hot, red hot, color, crimson, viridian, or violet.
2. Select an image brightness level, from 1–10.
3. Select an image contrast level, from 1–10.
4. Select an image sharpness level, from 1–10.

Step 4: Adjust Device Settings

1. Long press the **Menu (M) Button** to enter the main menu (see **Main Menu Options and Descriptions** on page 23 for detailed instructions) to:
 - a. Turn on Ultra-Clear mode.
 - b. Set the image hue to warm or cool.
 - c. Turn on the microphone.
 - d. Set the non-uniformity correction (NUC) mode to automatic or manual.
 - e. Set the date and time.
2. From the home screen, short press the **Up (Δ) Button** to adjust the digital zoom level to 1x, 2x, 3x, or 4x.
3. From the home screen, long press the **Up (Δ) Button** to turn on the PIP window.

8. Charging the Batteries

The LUMI Series comes with two rechargeable lithium-ion 18650 batteries, which allow for 4 hours of operation each. Fully charge the batteries before using the LUMI for the first time:

1. Insert a 18650 battery (12) into the battery charger (13) following the polarity markings (A) inside the battery slot.
2. Connect the USB-C cable (14) to the USB-C port (B) on the battery charger.
3. Connect the standard USB end of the data cable to:
 - a. The included 5V–2A USB power adapter (15); OR
 - b. Any standard USB 3.0 port on a laptop or computer.
4. During charging, the LED status indicator (C) on the battery charger will be solid red.

WARNING: Never use the battery charger with a USB power adapter that is greater than 5V–2A.

5. When the battery is fully charged, the LED status indicator will turn solid green. Remove the battery from the battery charger. Do not overcharge.

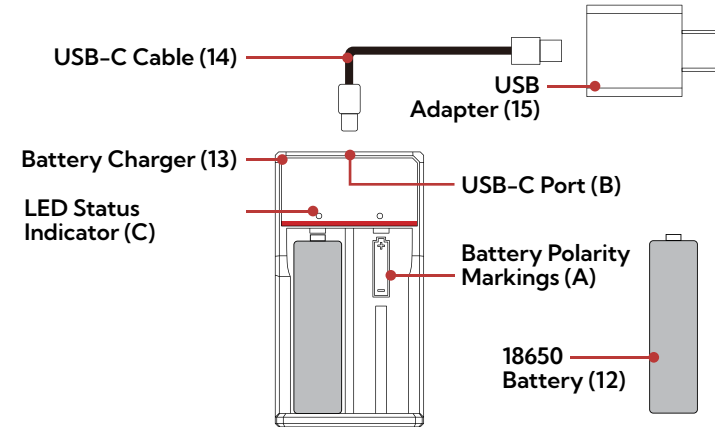

NOTES:

- When the LED status indicator flashes red, the battery charger is connected to a power source but no battery is installed.
- During use, the battery status icon in the status bar turns red  when the battery is below 20%; charge right away to avoid over-discharge and a reduction in battery capacity or service life.

9. Installing a Battery

1. Press the battery release button (9) down to open the battery compartment cover (10).
2. Insert a 18650 battery (12) into the battery compartment. The positive [+] battery terminal faces out and the negative [-] terminal faces in.
3. Flip the battery cover up and press to close it.

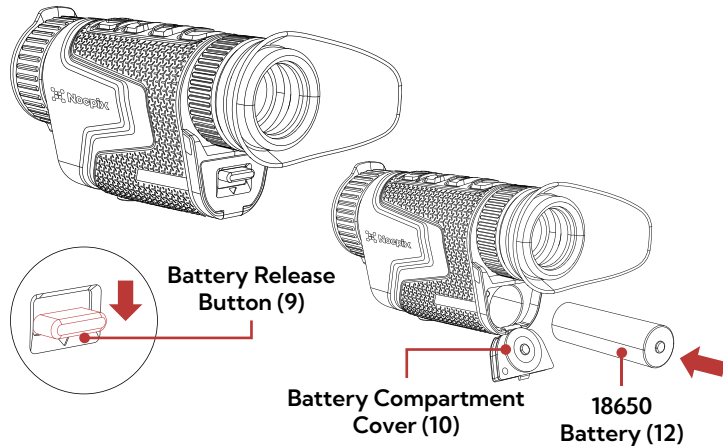

WARNING: The LUMI can only be powered by an 18650 battery. Using any other battery type may cause irreparable damage to the imager or cause a fire. Any damage from using an improper battery will not be covered by warranty.

10. Removing the Battery

To remove the battery from the LUMI:

1. Press the battery release button (9) down to open the battery cover (10).
2. Remove the 18650 battery.
3. Flip the battery cover up and press to close it.

11. Battery Safety Warnings

WARNING: Only use the factory-supplied battery charger. The use of any other charger may irreparably damage the battery or the charger and may cause a fire. Any damage from using an improper battery charger will not be covered by warranty.

WARNINGS:



- Do not use a battery charger, power adapter, or USB cable that has been modified or damaged.
- Do not expose the batteries to high temperatures or open flame, and do not immerse it in water.
- Do not leave the batteries unattended while charging.
- Do not leave the batteries charging for long periods after full charge is reached. Charging time should not exceed 24 hours.
- Keep batteries out of the reach of children and pets.
- The batteries are equipped with short-circuit protection. However, any situation that may cause short-circuiting should be avoided.
- Do not disassemble, modify, hit, or drop the batteries.
- Do not connect the batteries to any external device with an electrical current that exceeds permitted levels.
- Do not connect an external device with a current supply that exceeds the 3.0 USB port.

To maintain optimal battery capacity and service life:

- Avoid storing a fully charged or discharged battery for long periods. Partial charging of the battery is necessary if the battery will be stored for an extended period.
- Do not charge an extremely cold battery. Allow the battery to warm up for about 45 minutes before charging.
- Charge the batteries at a temperature range from 32 °F to 113 °F; otherwise, the service life of the battery may be reduced.
- The recommended operating temperature range is -4 °F to 122 °F. Avoid using the batteries above the maximum or below the minimum recommended temperature range as this may decrease the battery capacity or service life.

12. External Power Supply

The LUMI supports the use of a 5V external power supply, such as a mobile power bank. To connect to an external power supply:

1. Connect the USB-C cable (14) to the USB-C port (11) on the LUMI.
2. Connect the other end of the USB-C cable to the external power supply.
3. The LUMI will switch to operation from the external power supply.
4. In the status bar, the battery status  icon will change to the USB  icon.
5. If the external power supply is disconnected, the LUMI will switch automatically to the battery, if installed, without powering off.

NOTES:

- The external power supply does not charge the 18650 battery.
- Do not connect the LUMI to an external device with a power supply that exceeds the 3.0 USB cable.

13. Operating Instructions



WARNING!

Don't point the objective lens towards any intense energy sources, such as laser radiation or the sun. This may render the electronic components inoperative. The warranty does not cover damage caused by improper operation.

Using the Control Buttons

The LUMI is operated via four control buttons. The control buttons can be used to perform shortcut operations from the home screen, as well as in the menu and full-screen interfaces. See **Description of Control Buttons and Shortcuts** on page 6 for shortcut button details.

Powering On

1. Open the objective lens cap (1).
2. Long press the **Power**  **Button** for 3 seconds to turn on the imager. The Nocpix logo will appear..
3. To determine the current battery charge, check the battery status  icon in the status bar.

Powering Off



1. Long press the **Power**  **Button**. The shutdown screen will open, showing a 3-second countdown.
2. The LUMI will power off automatically when the countdown completes.

NOTE: Press any button during the 3-second countdown to stop the shutdown process and resume normal operation.

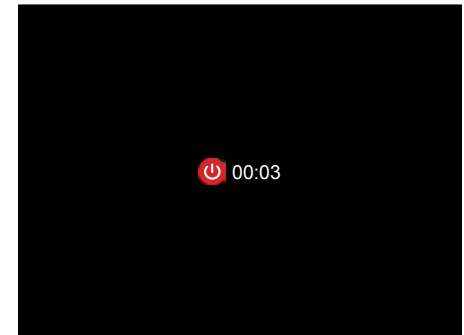
WARNING: If using an external power supply and no battery is installed, do not remove the power supply when saving data, as the data may not be saved.



Entering Standby Mode

1. To enter standby at any time from the home screen, short press the **Power**  **Button**.
2. Short press the **Power**  **Button** to exit standby.

Adjusting the Focus

ADJUSTING THE DIOPTER/EYEPIECE

1. Rotate the eyepiece diopter adjustment ring **(7)** at the rear of the imager right or left until the user interface is clear.
2. Look closely to ensure all icons and the status bar appear sharp and in focus. No additional diopter adjustments are required unless the user wishes to make changes.

NOTES:

- After the initial adjustment, there is no need to rotate the eyepiece adjustment ring **(7)** for long distances or other conditions.
- If necessary during standard use, the objective lens focus knob **(2)** may be rotated to adjust fine focus on the target object being observed. See **Focusing the Objective Lens** below.

FOCUSING THE OBJECTIVE LENS

To adjust the focus on the target object:









1. Rotate the objective lens focus knob **(2)** left or right to adjust fine focus.

NOTE: Re-adjusting the focus will be necessary if the distance to the target changes.

Status Bar Overview





The status bar at the top of the screen shows information on the operating status of the LUMI.



- 1 Ultra-clear:** Shows the Ultra-clear status, on  or off .
- 2 Total Magnification:** Shows the total magnification.
- 3 Non-Uniformity Correction (NUC) Mode:** Shows the non-uniformity correction (NUC) mode, automatic  or manual . A countdown timer will appear instead of the NUC mode when 5 seconds remain until an automatic NUC.
- 4 Microphone:** Shows the microphone status, on  or off .
- 5 Wi-Fi:** Shows the Wi-Fi status, on  or off .
- 6 Time:** Shows the current time in 24-hour format.
- 7 Battery Status:** Shows the battery status.

BATTERY STATUS

The battery icon color and fill level indicate the current battery status. The battery icon is replaced by the USB icon when an external power supply is connected.

COLOR / ICON	BATTERY STATUS
White Battery 	41% – 100%
Yellow Battery 	20% – 40%
Red Battery 	<20%; charge the battery right away.
USB 	No battery is installed; an external power supply or computer is connected via the charging cable.

Using the Quick Menu

In the quick menu, the color palette, image brightness, image contrast, and image sharpness can be quickly adjusted.

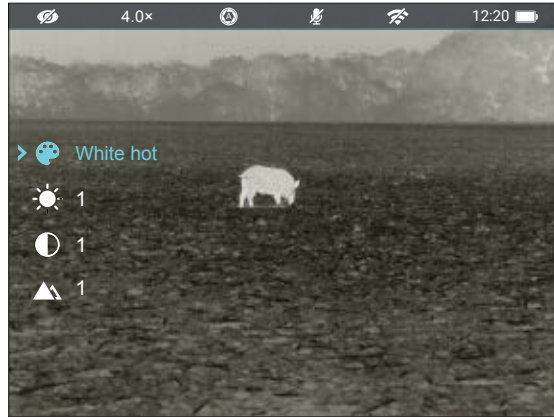

- On the home screen, short press the **Menu (M) Button** to enter the quick menu.
- Short press the **Up (Δ) or Down (▽) Button** to move between the menu options below. The selected menu item is highlighted in the background.
 - **Color Palette:** Short press the **Menu (M) Button** to set the color palette to white hot, black hot, red hot, color, crimson, viridian, or violet.
 - **Image Brightness:** Short press the **Menu (M) Button** to set the image brightness level, from 1–10.
 - **Image Contrast:** Short press the **Menu (M) Button** to set the image contrast level, from 1–10.
 - **Image Sharpness:** Short press the **Menu (M) Button** to set the image sharpness level, from 1–10.
- Long press the **Menu (M) Button** to save any changes and return to the home screen.
- After 5 seconds of inactivity, the system will automatically save any changes and return to the home screen.

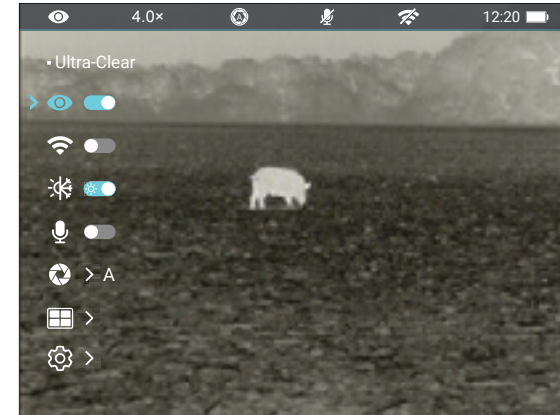

Navigating the Main Menu



- From the home screen, long press the **Menu (M) Button** to enter the main menu.
- Short press the **Up (Δ) or Down (▽) Button** to move through the menu options.
- A blue arrow **>** icon indicates the cursor position in the menu.
- Short press the **Menu (M) Button** to:
 - Change the parameters for the selected menu option; **OR**
 - Enter the submenu; **OR**
 - Confirm submenu changes and return to the previous menu.
- Long press the **Menu (M) Button** to confirm any changes and return to the home screen.
- Short press the **Power (⊞) Button** to return to the previous menu without saving.
- After 15 seconds of inactivity, the menu will automatically close and the interface will return to the home screen. Changes (except changes to toggle on / off menu items, such as Ultra-Clear and Wi-Fi) are not saved automatically.
- Upon exiting from the main menu the cursor location is stored for a single working session (until the LUMI is turned off). After restarting the LUMI and entering the menu, the cursor position will be at the first menu item.

14. Non-Uniformity Correction

A non-uniformity correction (NUC) allows a thermal imager's sensors to correct its pixels and eliminate any image defects caused by pixel drift. A NUC will be performed automatically each time the LUMI Series is powered on.

The LUMI has two non-uniformity correction (NUC) modes, automatic  and manual . In either mode, the user may choose to manually perform a NUC (shuttered or shutterless) at any time. See **Main Menu > Calibration Mode** on page 26 for instructions on setting the NUC mode.

Automatic NUC Mode

When automatic NUC mode is selected, the LUMI will perform a shuttered NUC automatically according to the internal software algorithm. There is no need to close the objective lens cap **(1)** as the imager's internal shutter covers the sensor. A countdown timer icon will appear when 5 seconds remain until an automatic NUC. Short pressing the Power button will interrupt a pending NUC. The timer will appear only after the microbolometer temperature has stabilized—after approximately 10 minutes of continuous operation of the LUMI.



NOTE: A manual NUC (see below) may be performed at any time.

Performing a Manual NUC

The user may independently determine the need to perform a shuttered or shutterless NUC based on the quality of the observed image. A manual NUC may be performed at any time from the home screen.



SHUTTERED NUC

It is not necessary to close the objective lens cap **(1)** during a shuttered NUC, as the internal shutter covers the sensor.

1. From the home screen, short press the **Up**  and **Down**  **Buttons** at the same time.
2. The internal shutter will cover the sensor and a shuttered non-uniformity correction (NUC) will be performed instantly.

SHUTTERLESS NUC

A shutterless NUC uses less power than a shuttered NUC because it does not use the imager shutter to cover the sensor; instead, the user must close the lens cap **(1)**.

1. Close the objective lens cap **(1)**.
2. From the home screen, long press the **Up**  and **Down**  **Buttons** at the same time.
3. A prompt to close the lens cap **(1)** appears onscreen. The shutterless NUC starts after about 2 seconds.

NOTE: If the lens is not properly covered, a temporary "image burn" will remain in the image until the next non-uniformity correction. This "image burn" is temporary and is not a defect or sign of permanent damage.



15. Photography and Video Recording

The LUMI is equipped with video recording and image capture. All videos and photos are automatically saved to the built-in 32 GB memory storage.

NOTE: Photo and video files are named with the time and date; therefore, it is recommended to set the date and time before using the photo and video functions. See **Settings Menu > Date and Time** on page 27. Alternatively, the date and time may be synchronized in the NOCPIX App.

Photography

To take a photo:



1. From the home screen, short press the **Down**  **Button**.
2. The image will freeze for 0.5 seconds and the camera  icon will appear briefly in the upper-left corner of the screen to indicate a photo was taken.



NOTE: A red warning icon (ⓘ) appears next to the camera icon in the upper-left corner of the screen when insufficient memory storage is available. Transfer video and image files to other storage media to free up space on the memory card.

Video Recording

To record video:

1. Turn on the microphone in the main menu. See **Main Menu > MIC** on page 25.
2. From the home screen, long press the **Down**  **Button** to start a video recording.
3. When the video recording starts, the recording timer, in HH:MM:SS (hour, minute, second) format, appears in the upper-right corner of the screen.
4. When recording, short press the **Down**  **Button** to take a photo.
5. Long press the **Down**  **Button** to stop and save the video recording.



Video and Photography Notes

- You may enter and navigate the menu during video recording. The user interface (the status bar, icons, and menu) is captured in recorded video or photo files.
- Recorded photos and videos are saved to the memory card.
 - Photos are saved as PIC_HHMMSS.jpg.
 - Videos are saved as VIDEO_HHMMSS.mp4.
 - HHMMSS is hour, minute, second.
- The number of recorded files is limited only by the capacity of the internal memory.
- Regularly check the available memory storage space and move video footage and images to other storage media to free up space on the memory card.

16. Accessing the Internal Memory

When the LUMI is turned on and connected to a computer via the included data cable, it is recognized by the computer as a flash memory (USB) drive. This allows the user to access the saved multimedia files and copy or delete any desired files.

To access the internal memory:

1. Turn on the LUMI.
2. Connect the LUMI to your computer via the included USB-C cable (14).
3. Double-click **My Computer** on your computer desktop.
4. Double-click to open the device named **NOCPIX**.
5. Double-click to open the device named **LUMI** to access the built-in memory. Recorded photos and videos are separated into folders by date, YYYYDDMM.
6. Select the desired files or folders to copy or delete.

17. Using the NOCPIX App

The LUMI can be operated using the NOCPIX App when connected to a tablet or smartphone or via Wi-Fi.

1. Download the App for free and install it on your device:
 - a. Scan a QR code to download it from the App Store or Google Play; **OR**
 - b. Download the App from any app store.
2. Connect the LUMI to Wi-Fi:
 - a. Turn on the Wi-Fi. See **Main Menu > Wi-Fi** on page 24 for instructions.
 - b. Open the App and click the **Connect Device** button. Then, click **Connect Phone WLAN**.
 - c. On the mobile device, go to **Settings > Wi-Fi**.



- d. Select the LUMI from the list of Wi-Fi networks. It will appear in the list as "LUMI_XXXXX-XXXXXXXX," where XXXXX-XXXXXXXX is the device serial number.
 - e. Enter the Wi-Fi password and tap the **Join button**. The default password is 12345678.
3. Operate the LUMI via the App:
- a. Take real-time photos and videos, with or without audio.
 - b. View, share, download, and delete photos and videos taken via the App, which are saved to the mobile device.
 - c. Change the Wi-Fi password and SSID.
 - d. Synchronize the date and time from the mobile device.
 - e. Update the LUMI firmware.

NOTE: When a factory reset is performed, the Wi-Fi SSID and password are reset to the defaults, LUMI_XXXXX-XXXXXXXX and 12345678. See **Settings Menu > Factory Reset** on page 29.

18. Digital Zoom

The LUMI will quickly increase the base magnification by enlarging the image digitally from 1 to 4 times (L35) or from 1 to 8 times (H35).



To use digital zoom:

1. From the home screen, short press the **Up  Button** to toggle through the digital zoom levels, 1x, 2x, 3x, to 4x (L35) or 1x, 2x, 4x, 8x (H35). The total magnification is displayed in the status bar.

19. Picture in Picture

The Picture in Picture (PIP) function opens a small floating window with a magnified image view at the top of the screen. PIP allows for improved aiming while still being able to see the wide field of view in the main body of the screen.

To activate Picture in Picture mode:

1. From the home screen, long press the **Up  Button**. A 2x zoomed image, centered on the screen, will appear at the top of the screen. Please note that the PIP image is 2x that of the total magnification shown on the left side of the status bar.
2. To exit PIP mode, long press the **Up  Button** again.

NOTE: When the image in the main body of the screen is magnified via digital zoom, the PIP image will enlarge accordingly.

20. Ultra-Clear Mode

Ultra-Clear mode improves the image quality in inclement weather conditions, such as rain, fog, high humidity, or high temperatures as these conditions all result in lower thermal contrast. Ultra-Clear mode enhances the NETD value of the thermal sensor and improves the sensor's response rate to these challenging environment conditions. See **Main Menu > Ultra-Clear** on the next page.

Ultra-Clear mode provides:

- Improved image quality and clarity; images are crisper and sharper.
- Increased image detail.
- Improved recognition of observed targets.

21. Main Menu Options and Descriptions

Menu and submenu options, from left to right are:









- **Main Menu:** Ultra-Clear, Wi-Fi, Image Hue, MIC, Calibration, Gallery, Settings.
 - **Settings Menu:** Date, Time, Language, Electronic Image Stabilization, Factory Reset, Info.

Menu option details, descriptions, and navigation instructions are listed in order on the following pages.

Ultra-Clear

Turn Ultra-Clear mode on / off

When Ultra-Clear mode is turned on, the image contrast is enhanced, which is suitable for rainy, foggy, or low-contrast conditions.

1. Long press the **Menu ** Button to enter the main menu.
2. Short press the **Up ** or **Down ** Button to select the Ultra-Clear  menu item.
3. Short press the **Menu ** Button to turn Ultra-Clear on / off.
4. The Ultra-Clear status, on  or off , appears in the status bar.
5. Long press the **Menu ** Button to return to the home screen.



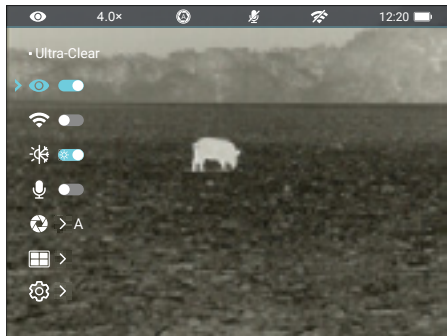

NOTE: When Ultra-Clear mode is turned on and off, the LUMI will automatically perform a shuttered non-uniformity correction.



Wi-Fi

Turn Wi-Fi on / off

Turn on Wi-Fi to operate the LUMI via the NOCPIX App.

1. Long press the **Menu ** Button to enter the main menu.
2. Short press the **Up ** or **Down ** Button to select the Wi-Fi  menu item.
3. Short press the **Menu ** Button to toggle Wi-Fi on / off. The first three times Wi-Fi is turned on, the default Wi-Fi password will appear briefly to the right of the toggle. The password will no longer be displayed after the default password is changed.

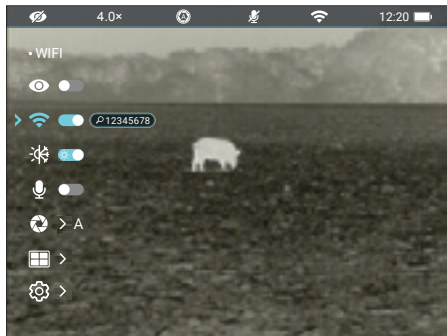











4. The Wi-Fi status, on  or off , appears in the status bar.
5. Long press the **Menu ** Button to return to the home screen.

Image Hue

Toggle between warm and cool image hue modes

1. Long press the **Menu ** Button to enter the main menu.
2. Short press the **Up ** or **Down ** Button to select the image hue  menu item.
3. Short press the **Menu ** Button to toggle between warm  mode (toggle is on) and cool  mode (toggle is off).
4. Long press the **Menu ** Button to return to the home screen.

NOTES:



- Cool mode provides a brighter image and warm mode provides a softer image and reduces eye strain.
- Image hue is available when using the white hot or black hot color palette.

MIC

Turn the microphone on / off

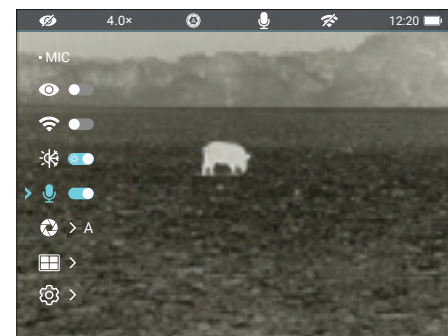
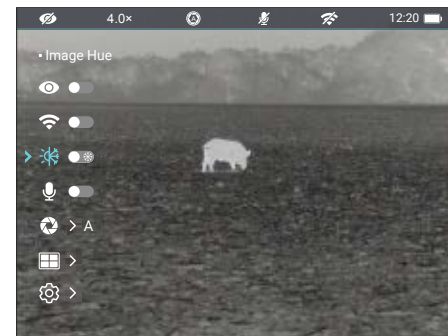
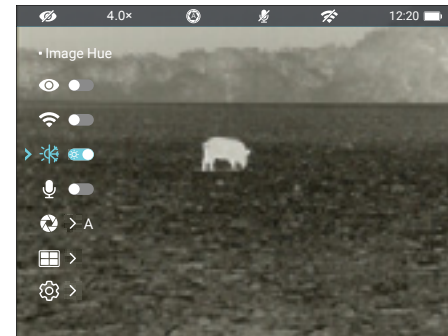
1. Long press the **Menu ** Button to enter the main menu.
2. Short press the **Up ** or **Down ** Button to select the MIC  menu item.



- Short press the **Menu (M) Button** to turn the microphone on / off. The microphone status,  or off , appears in the status bar.
- Long press the **Menu (M) Button** to return to the home screen.

Calibration

Set the non-uniformity correction mode to automatic or manual

- Long press the **Menu (M) Button** to enter the main menu.
- Short press the **Up (▲) or Down (▼) Button** to select the calibration  menu item.
- Short press the **Menu (M) Button** to move through the submenu options, Automatic (A) and Manual (M). The selected NUC mode, A or M, appears in the status bar.
- Long press the **Menu (M) Button** to return to the home screen.



Gallery

View photos and videos saved to the device

- Long press the **Menu (M) Button** to enter the main menu.
- Short press the **Up (▲) or Down (▼) Button** to select the gallery  menu item.
- Short press the **Menu (M) Button** to enter the submenu.
- Short press the **Up (▲) or Down (▼) Button** to move through the multimedia folders. Folders are named by date in YYYYMMDD format.

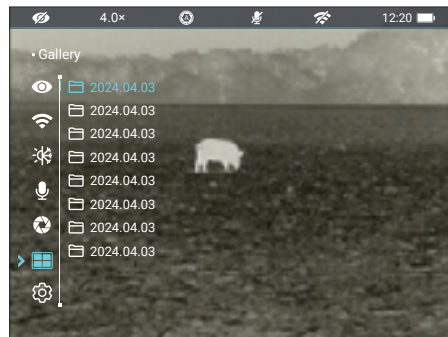

- Short press the **Menu (M) Button** to select a folder, then use the **Up (▲) and Down (▼) Buttons** to navigate through the image and video files. A thumbnail of the selected file appears on the right side of the screen.
- Short press the **Menu (M) Button** to view an image or video in full screen. When viewing video files, short press the **Menu (M) Button** to play and pause the video.
- Short press the **Power (⏻) Button** to return to the list of files.
- Long press the **Menu (M) Button** to return to the home screen.

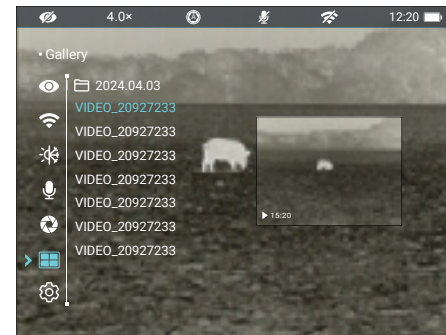

Settings Menu

Adjust the general settings

- Long press the **Menu (M) Button** to enter the main menu.
- Short press the **Up (▲) or Down (▼) Button** to select the settings  menu item.
- Short press the **Menu (M) Button** to enter the settings submenu.

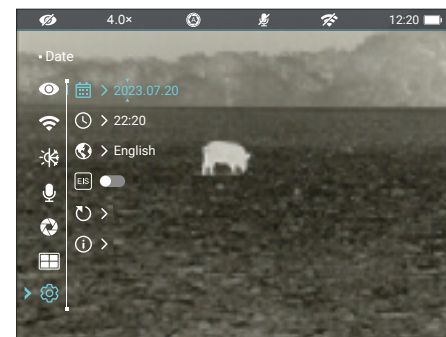

SETTINGS MENU > DATE

Set the date

- In the settings submenu, short press the **Up (▲) or Down (▼) Button** to select the date  menu item.
- Short press the **Menu (M) Button** to edit the date, shown in YYYY.MM.DD format. A blue arrow will appear above and below the year digit.

- Short press the **Up** (▲) or **Down** (▼) **Button** to select the correct value for each digit (year, month, and day).
- Short press the **Menu** (M) **Button** to switch between digits. The two arrows move to indicate the selected digit.
- Long press the **Menu** (M) **Button** to save the date and return to the home screen.

SETTINGS MENU > TIME (🕒)

Set the time

- In the settings submenu, short press the **Up** (▲) or **Down** (▼) **Button** to select the time (🕒) menu item.
- Short press the **Menu** (M) **Button** to edit the time, shown in 24-hour format, HH:MM. A blue arrow will appear above and below the hour digit.
- Short press the **Up** (▲) or **Down** (▼) **Button** to select the correct value for each digit (hour and minute).
- Short press the **Menu** (M) **Button** to switch between digits. The two arrows move to indicate the selected digit.
- Long press the **Menu** (M) **Button** to save the time and return to the home screen. The set time appears in the status bar.

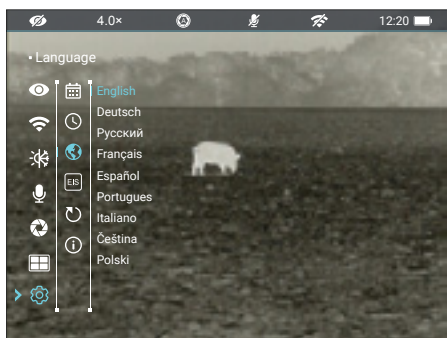
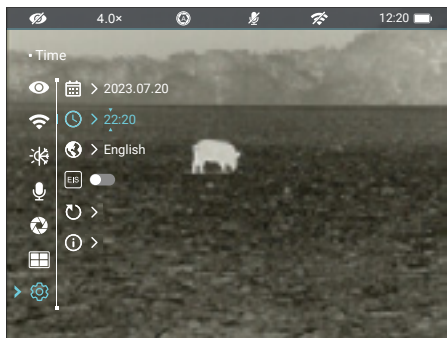

SETTINGS MENU > LANGUAGE (🌐)

Select the language

- In the settings submenu, short press the **Up** (▲) or **Down** (▼) **Button** to select the language (🌐) menu item.
- Short press the **Menu** (M) **Button** to enter the submenu.

- Short press the **Up** (▲) or **Down** (▼) **Button** to move through the language options.
- Long press the **Menu** (M) **Button** to confirm the selection and return to the home screen.

SETTINGS MENU > ELECTRONIC IMAGE STABILIZATION (EIS)

Turn electronic image stabilization on / off

- In the settings submenu, short press the **Up** (▲) or **Down** (▼) **Button** to select the electronic image stabilization (EIS) menu item.
- Short press the **Menu** (M) **Button** to turn image stabilization on / off.
- Long press the **Menu** (M) **Button** to return to the home screen

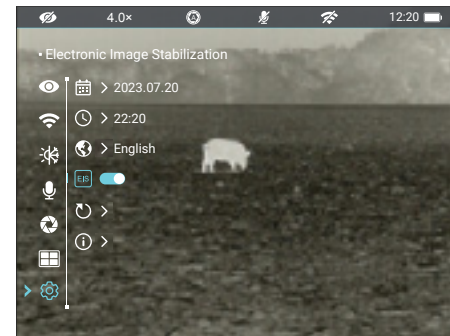

SETTINGS MENU > FACTORY RESET (🔄)

Restore factory default settings

- In the settings submenu, short press the **Up** (▲) or **Down** (▼) **Button** to select the factory reset (🔄) menu item.
- Short press the **Menu** (M) **Button** to enter the submenu.
- Two options, Yes and No, appear; Yes will restore factory settings and No will cancel the operation.
- Short press the **Menu** (M) **Button** to select **Yes** to confirm the factory reset. Factory settings will be restored and the LUMI will reboot automatically; **OR**
- Short press the **Up** (▲) or **Down** (▼) **Button** to select **No** and short press the **Menu** (M) **Button** to confirm cancellation of the factory reset and return to the submenu.

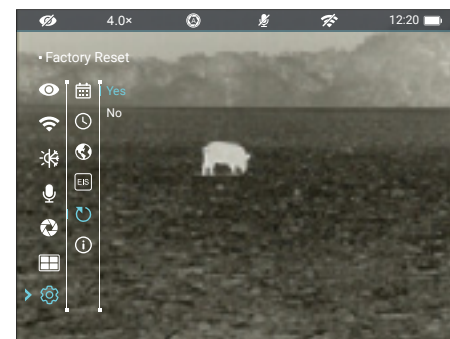

FACTORY RESET NOTES:

- The screen will go dark and the factory restart will begin after a pause of about 10 seconds.
- A factory reset cannot be undone.
- The settings listed below will be reset to the factory defaults:
 - Color Palette: White Hot
 - Image Brightness: 5
 - Image Contrast: 5
 - Image Sharpness: 5
 - Digital Zoom: 1x
 - Ultra-Clear mode: Off
 - Wi-Fi: Off
 - Image Hue: Cool
 - Microphone: Off
 - Calibration: Automatic
 - Language: English
 - Wi-Fi Password: 12345678
 - Wi-Fi SSID: LUMI_XXXXX-XXXXXXXX

SETTINGS MENU > INFO ⓘ

Show device information

1. In the settings submenu, short press the **Up** ⬆️ or **Down** ⬇️ **Button** to select the info ⓘ menu item.
2. Short press the **Menu** Ⓜ️ **Button** to enter the submenu.
3. The info submenu will display information about the LUMI: the model number, GUI, ROOTFS, KERNEL, and UBOOT versions, part and serial numbers, and FCC ID.
4. Long press the **Menu** Ⓜ️ **Button** to save and return to the home screen.

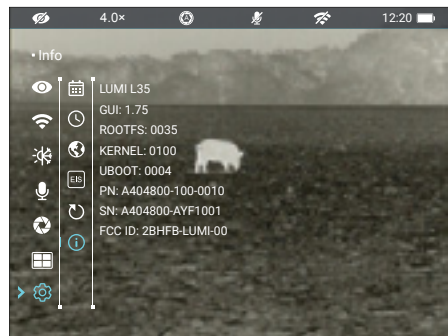

22. Warranty

At iRayUSA we're first and foremost hunters and users of our products and we understand that failure isn't an option. We also understand that having to wait extended periods for repair isn't something that a customer should have to put up with when something does go wrong. During your published warranty period, iRayUSA will repair or replace, at its discretion, any optic that becomes defective during normal use. Additionally, if we cannot fix your optic in less than one week, we will offer to replace it with a replacement product in like or better condition. If you would rather wait for your specific optic to be repaired, we can handle that too.

We know you've never seen this from a thermal manufacturer and neither have we; that's why we started iRayUSA.

Our warranty follows the product and is not tied to the original owner. The warranty period is tied to the date of sale to the dealer. This warranty only covers normal use and does not cover cosmetic damage, normal wear, intentional damage, theft, loss, any act of God, or a condition caused by use other than intended. Any product that is modified, opened, or tampered with will void any warranty coverage. Any serial number damage or alteration on the product will be considered a modification. Be sure to register your LUMI imager at irayusa.com/register.

To return a product for repair:

1. Go to irayusa.com/warranty and click the **Request an RMA button** to request an RMA number. Returns will not be accepted without an RMA.
2. The customer is responsible for shipping the product to iRayUSA, per the instructions included with the RMA. iRayUSA will return the product at no cost.

WARRANTY NOTES:

- The one-week timeline starts from the time of receipt of the product at iRayUSA.
- iRayUSA is not liable for any damages or loss incurred when shipping to iRayUSA.
- This warranty gives you specific legal rights, and you may also have other rights which vary from state to state.

Please give us a call at **800-769-7125**, visit irayusa.com/warranty, or email info@irayusa.com with any questions.

23. Basic Inspection

It is recommended to carry out a technical inspection before each use. Please check the following:

- The imager appearance: there should be no cracks in the body or visible damage.
- The condition of the objective lens and eyepiece: there should be no cracks, greasy spots, dirt, or other deposits on the lens.
- The rechargeable battery should be fully charged.
- The control buttons should be in working order.

24. Basic Maintenance

Always replace the objective lens cap (1) after use to avoid damaging or scratching the lens. Never touch the lens directly; oil from your skin can damage the lens coating and surface.

Basic maintenance should be carried out at least twice a year and includes the following steps:

- Wipe the surface of the external metal and plastic components with a clean, dry cotton cloth. Do not use chemical, corrosive, or abrasive cleaners. Canned air may also be used to clean the external components.

ISSUE	POSSIBLE CAUSES
The LUMI will not turn on.	The 18650 battery is very low or has completely discharged.
The LUMI can not connect to a computer or external power supply.	External power supply has completely discharged.
	Computer is turned off.
	USB-C cable is damaged.
The LUMI can not connect to the mobile device (smartphone or tablet).	Wi-Fi is not turned on.
	Wrong Wi-Fi password entered.
	Too many Wi-Fi signals nearby, which may cause interference.

- Clean the electric contacts and battery slots on the imager using a non-greasy organic solvent.
- Check the lens and eyepiece. If necessary, remove any dirt or sand from the optics; a non-contact cleaning method is preferred.
- Cleaning the exterior of the lens should only be done with the included microfiber lens cloth or a similar product. Only clean the lens when it is visibly soiled. Frequent wiping or cleaning can degrade the anti-reflective lens coating.

25. General Troubleshooting

The troubleshooting table below lists issues that may occur when operating the LUMI. Carry out the recommended troubleshooting steps in the order shown in the table. Please contact iRayUSA at 800-769-7125 or irayusa.com/support or an authorized vendor for assistance before attempting to perform any modifications or repairs beyond the scope of the troubleshooting procedures in this manual. Unauthorized repairs or modifications will void your warranty.

TROUBLESHOOTING STEPS
Charge the battery.
Check the external power supply and charge it if necessary.
Power on the computer.
Replace the cable.
Turn on the Wi-Fi in the main menu. See Main Menu > Wi-Fi on page 24.
On the mobile device, go to Settings > Wi-Fi and enter the correct password. The default password is 12345678. See Main Menu > Wi-Fi on page 24.
Move the LUMI and mobile device to an area with no or fewer Wi-Fi signals.

ISSUE	POSSIBLE CAUSES
Wi-Fi signal is lost or interrupted.	The device is out of range of a strong Wi-Fi signal, or there are obstacles (such as concrete walls) between the device and the signal.
The image is blurry, the background is uneven, or vertical lines or artifacts are present.	Non-uniformity correction is required.
The image is too dark.	Image brightness level is too low.
The GUI is clear, but the image is blurry.	The lens is not focused.
	There is dust or ice on the interior or exterior surface of the lens.
	There is condensation on the interior or exterior surface of the lens.
Observed target disappears.	Observing the target through glass.
The LUMI will not focus.	Image settings are not optimal for the current environmental conditions or the object being observed.
Image quality is low or the detection range is reduced.	Environmental conditions, such as snow, rain, humidity, and fog.
When the LUMI is used in low-temperature conditions, the image quality of the surroundings is worse than in warm-temperature conditions.	Environmental conditions.

TROUBLESHOOTING STEPS
<ul style="list-style-type: none"> Try again when the Wi-Fi signal is stable. Move the LUMI closer to the Wi-Fi signal.
Perform a non-uniformity correction. See Non-uniformity Correction on page 18 and Using the Quick Menu on page 16.
Adjust the image brightness in the quick menu. See Using the Quick Menu on page 16.
<ul style="list-style-type: none"> Adjust the focus on the target by rotating the objective focus knob (2). Adjust the image sharpness in the quick menu. See Using the Quick Menu on page 16.
<ul style="list-style-type: none"> Wipe the external optical surface with the included microfiber lens cloth.
<ul style="list-style-type: none"> Wipe the external optical surface with the included microfiber lens cloth. Allow the LUMI to dry by leaving it in a warm, dry environment for at least 4 hours.
Remove any glass windows from the field of view.
<ul style="list-style-type: none"> Check the external surface of the lens and eyepiece and, where necessary, wipe away any dust, condensation, frost, etc. In cold weather, you can use special anti-fogging coatings, such as those made for corrective glasses. Adjust the focus on the target by rotating the objective focus knob (2). Adjust the image sharpness in the quick menu. See Using the Quick Menu on page 16. Adjust the image and device settings. See Quick Start Guide on page 7. Turn on Ultra-Clear mode. See Main Menu > Ultra-Clear on page 24.
Turn on Ultra-Clear mode. See Main Menu > Ultra-Clear on page 24.
In warm-temperature conditions, objects being observed (surroundings and background) heat up differently because of thermal conductivity, thereby generating a high-temperature contrast. Accordingly, image quality produced by the imager will be higher. In low-temperature conditions, the background will cool down to roughly the same temperature, and thus the temperature contrast is substantially reduced and image detail can go down as there is less contrast in the scene. This is a normal function of a thermal imager and is no indicator of actual detector performance.

26. Notes



2601 State Hwy 121, Bldg 3, Ste 306
Lewisville, TX 75056
800-769-7125 | 682-499-0047
info@irayusa.com

IRAY-PR218 A24H20CT