

NEITH

DC32-4MP

DIGITAL DAY & NIGHT VISION
CLIP-ON

© 2023 AGM Global Vision, LLC. All rights reserved.

This documentation is subject to change without notice.

No parts of this manual, in whole or in part, may be copied, photocopied, translated, or transmitted by any electronic medium or in machine-readable form without the prior written permission of AGM Global Vision, LLC.

If you have questions that are not covered in this manual, or need service, contact AGM Global Vision customer support for additional information prior to returning a product.

AGM Global Vision, LLC

173 West Main Street

PO Box 962

Springerville, AZ 85938

Tel. 928.333.4300

support@agmglobalvision.com

www.agmglobalvision.com

EXPORT INFORMATION

Buyer acknowledges that all products supplied by AGM Global Vision, LLC are subject to U.S. export control laws, including, but not limited to, the Export Administration Regulations, the International Traffic in Arms Regulations, the International Economic Emergency Powers Act, and various U.S. embargoes and sanctions. AGM Global Vision products may not be exported, re-exported, or transferred contrary to U.S. export control laws. In particular, AGM Global Vision products may not be exported, re-exported, or transferred to prohibited countries, individuals, organizations, or entities, including but not limited to those individuals and entities listed on the List of Specially Designated Nationals and Blocked Persons administered or maintained by the U.S. Office of Foreign Assets Control ("OFAC"), the various lists maintained by the Bureau of Industry and Security of the Department of Commerce, and the U.S. State Department and Buyer represents and warrants that neither Buyer nor any of its officers, directors, or employees are on such lists. Distribution or resale by Buyer to such countries, individuals, organizations, or entities is expressly prohibited. Buyer has and will maintain a positive process to ensure compliance with this Section.

FCC INFORMATION

Please note that changes or modification not expressly approved by the party responsible for compliance could void the user's authority to operate the equipment.

This equipment complies with FCC/IC RSS-102 radiation exposure limits set forth for an uncontrolled environment.



FCC compliance: This product has been tested and found to comply with the limits for a Class B digital device, pursuant to Part 15 of the FCC Rules. These limits are designed to provide reasonable protection against harmful interference in a residential installation.

This product generates, uses, and can radiate radio frequency energy and, if not installed and used in accordance with the instructions, may cause harmful interference to radio communications. However, there is no guarantee that interference will not occur in a particular installation. If this product does cause harmful interference to radio or television reception, which can be determined by turning the equipment off and on, the user is encouraged to try to correct the interference by one or more of the following measures:

- Reorient or relocate the receiving antenna.
- Increase the separation between the equipment and receiver.
- Connect the equipment into an outlet on a circuit different from that to which the receiver is connected.
- Consult the dealer or an experienced radio/TV technician for help.

FCC Conditions

This device complies with part 15 of the FCC Rules. Operation is subject to the following two conditions:

1. This device may not cause harmful interference.
2. This device must accept any interference received, including interference that may cause undesired operation.

EU CONFORMITY STATEMENT



This product and - if applicable - the supplied accessories too are marked with "CE" and comply therefore with the applicable harmonized European standards listed under the EMC Directive 2014/30/EU, the RoHS Directive 2011/65/EU



2012/19/EU (WEEE directive): Products marked with this symbol cannot be disposed of as unsorted municipal waste in the European Union. For proper recycling, return this product to your local supplier upon the purchase of equivalent new equipment, or dispose of it at designated collection points. For more information see: www.recyclethis.info



2006/66/EC (battery directive): This product contains a battery that cannot be disposed of as unsorted municipal waste in the European Union. See the product documentation for specific battery information. The battery is marked with this symbol, which may include lettering to indicate cadmium (Cd), lead (Pb), or mercury (Hg). For proper recycling, return the battery to your supplier or to a designated collection point. For more information see: www.recyclethis.info

INDUSTRY CANADA ICES-003 COMPLIANCE

This device meets the CAN ICES-3 (B)/NMB-3(B) standards requirements.

LIST OF CONTENTS

TITLE	PAGE
Safety Summary	5
1. GENERAL INFORMATION	7
1.1 System Description	7
1.2 Standard Components	8
1.3 Optional Equipment	8
1.4 Key Features	9
2. OPERATING INSTRUCTIONS	10
2.1. Basic Operations	10
2.2 Main Function	17
2.3 Client Software Introduction	23
3. MAINTENANCE	24
3.1 Maintenance	24
3.2 Troubleshooting	25
4. WARRANTY INFORMATION	26
4.1 Warranty Information and Registration	26
5. SPECIFICATIONS	28
5.1 Specifications	28

SAFETY SUMMARY

- Read and follow all instructions
- Read all warnings
- Only use the attachments/accessories specified by the manufacturer
- All service must be provided by the manufacturer

WARNING:

This product contains natural rubber latex, which may cause potentially fatal allergic reactions! If you are allergic to latex, it is important that you strictly avoid exposure to products that contain it.

WARNING AND CAUTIONS:

Transportation

- Keep the device in original or similar packaging while transporting it.
- Keep all wrappers after unpacking them for future use. In case of any failure occurred, you need to return the device to the factory with the original wrapper. Transportation without the original wrapper may result in damage on the device and the company shall not take any responsibilities.
- DO NOT drop the product or subject it to physical shock. Keep the device away from magnetic interference.

Power Supply

- The battery charger is included in the package. The input voltage for the supplied battery charger should meet the Limited Power Source (5 VDC, 2 A).
- The power source should meet limited power source or PS2 requirements according to IEC 60950-1 OR ICE 62368-1 standard.
- Make sure the plug is properly connected to the power socket.
- DO NOT connect multiple devices to one power adapter, to avoid overheating or fire hazards caused by overload.

Battery

- Improper use or replacement of the battery may result in explosion hazard. Replace with the same or equivalent type only.
- The battery type is 18650 with the protection board, and the battery size should be 19 mm × 70 mm. The rated voltage is 3.6 VDC, and the battery capacity is 3200 mA. Dispose of used batteries in conformance with the instructions provided by the battery manufacturer.
- Make sure the battery temperature is between 0 °C to 45 °C (32 °F to 113 °F) when charging.
- For long-term storage of the battery, make sure it is fully charged every half year to ensure the battery quality. Otherwise, damage may occur.
- Do not charge other battery types with the supplied charger. Confirm there is no flammable material within 2 m of the charger during charging.
- DO NOT place the battery near heating or fire source. Avoid direct sunlight.
- DO NOT swallow the battery to avoid chemical burns.

- DO NOT leave the battery in places accessible for children.
- The battery cannot be charged with external power source directly.
- The device cannot be charged, please use the supplied charger to charge the replaceable battery.

Maintenance

- If the product does not work properly, please contact your dealer or the nearest service center. We shall not assume any responsibility for problems caused by unauthorized repair or maintenance.
- Wipe the device gently with a clean cloth and a small quantity of ethanol, if necessary.
- If the equipment is used in a manner not specified by the manufacturer, the protection provided by the device may be impaired.
- Clean the lens with soft and dry cloth or wiping paper to avoid scratching it.

Using Environment

- Make sure the running environment meets the requirement of the device. The operating temperature shall be -30°C to 55°C (-22°F to 131°F), and the operating humidity shall be 95% or less.
- DO NOT expose the device to extremely hot, cold, dusty, corrosive, saline-alkali, or damp environments.
- This device can only be safely used in the region below 2000 meters above the sea level.
- Avoid equipment installation on vibratory surface or places subject to shock (neglect may cause equipment damage).
- DO NOT aim the lens at the sun or any other bright light.

EMERGENCY:

- If smoke, odor, or noise arises from the device, immediately turn off the power, unplug the power cable, and contact the service center.

1 GENERAL INFORMATION

1.1 SYSTEM DESCRIPTION

The Neith DC is a digital day & night vision clip-on system that allows quick transformation of day optics into a night vision device without any special tools or equipment. This digital scope has an advanced ultra-low light optical detector and 1920×1080 OLED display – providing full-color clarity in daytime and classic black & white viewing at night. The device supports multiple display modes including, day mode, night mode, defog mode, and more. The scope is equipped with built-in memory storage for video recording and image capture. A Wi-Fi module for live video streaming and video/image recording via AGM Connect application is also available.

A built-in long-range infrared illuminator provides advanced viewing capabilities and is ideally suited for operations in low or no ambient lighting conditions. One 18650 rechargeable battery provides long continuous operation. An external 5V power bank (battery pack) can be easily connected via a USB connector for a significant increase in operating time.

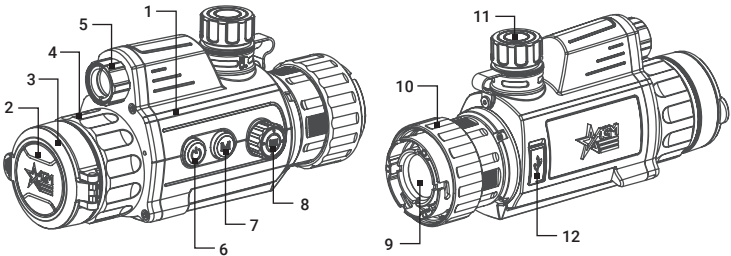

FIGURE 1-1. MAIN PARTS

TABLE 1-1. MAIN PARTS

ITEM	DESCRIPTION
1	Body
2	Lens Cap
3	Front Lens Assembly
4	Focus Ring
5	IR Focus Ring
6	Power Button

ITEM	DESCRIPTION
7	Mode Button
8	Operation Wheel
9	Output Lens Assembly
10	Adapter Fixing Ring
11	Battery Compartment
12	USB Type-C Interface

1.2 STANDARD COMPONENTS

The standard components are shown in Figure 1-2 and listed in Table 1-2. The ITEM column indicates the number used to identify items in Figure 1-2.

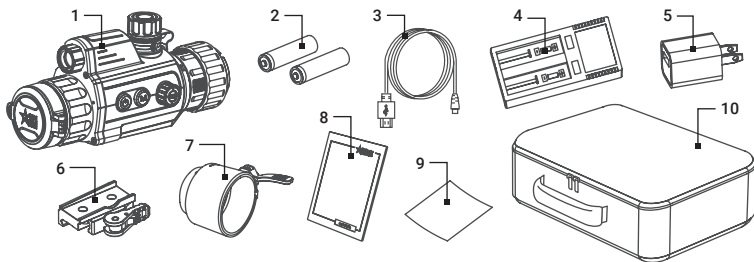

FIGURE 1-2. STANDARD COMPONENTS

TABLE 1-2. STANDARD COMPONENTS

ITEM	DESCRIPTION	QUANTITY
1	Clip-On	1
2	18650 Rechargeable Battery	2
3	USB Cable	1
4	Battery Charger	1
5	Power Adapter	1
6	QR Mount*	1
7	Day Scope Front Adapter*	1
8	User Manual	1
9	Lens Cloth	1
10	Carrying Case	1

*Mounting kit depends on the region of sale.

1.3 OPTIONAL EQUIPMENT

Optional items are shown in Figure 1-3 and listed in Table 1-3.

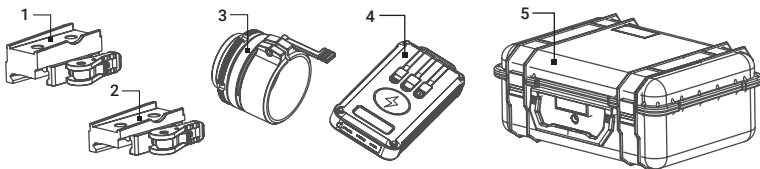

FIGURE 1-3. OPTIONAL EQUIPMENT

TABLE 1-3. OPTIONAL EQUIPMENT

ITEM	DESCRIPTION	PART NO.
1	AGM-2113 ADM Single Lever QR Mount (Height: 1.03")	6306LSR1
2	AGM-2114 ADM Low Base Single Lever QR Mount (Height: 0.78")	63061141
3	Front Q-R adapter: ARM52-56	6306RC61
	Front Q-R adapter: ARM52-50	6306RC51
	Front Q-R adapter: ARM52-44	6306RC41
	Front Q-R adapter: ARM52-30	6306RC31
4	AGM Power Bank	6308APB1
5	Hard Case for Storage/Transportation	6610HCS1

1.4 KEY FEATURES

- Quick conversion of daytime optics into night vision device
- Mounts in front of any daytime scope, no re-zeroing is required
- 2560×1440 ultra-low light optical detector
- Supports Day/Night mode
- Detection range up to 400 m
- Built-in long-range IR illuminator
- On-board video/audio recording and image capture
- Shot-Activated Recording (SAR)
- 64 GB built-in EMMC memory
- Wi-Fi data transmission
- High-resolution OLED display
- Standby mode
- Replaceable and rechargeable Li-Ion battery
- External power supply capability
- Waterproof & shockproof
- 3-year warranty

2 OPERATING INSTRUCTIONS

2.1. BASIC OPERATIONS

2.1.1 UNPACKING

The following steps must be completed prior to each mission.

1. Open the carrying case, remove the device, and verify that all components are included.
2. Inspect the device for any obvious evidence of damage to the optical surfaces, body, operation buttons, etc. Ensure that all optical surfaces are clean and ready for use. Clean all optical surfaces with a lens tissue.

2.1.2 BATTERY INSTALLATION

1. Turn the battery cover (A) counterclockwise to open it.
2. Make sure the battery is fully charged. Insert the battery (B) into the battery compartment (C) with the positive mark inward.
3. Turn the battery cover clockwise to tighten it.

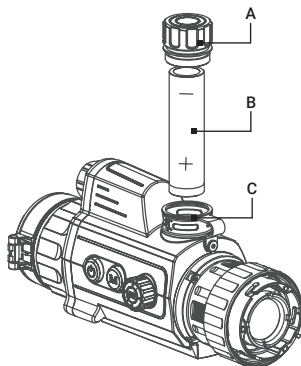

FIGURE 2-1. BATTERY INSTALLATION

NOTE:

Remove the battery from the battery compartment if the device is not used for a long time.

2.1.3 CONTROL BUTTONS

The Neith DC controls are shown in Figure 2-2 and are defined in Table 2-1.

Each button is responsible for some functions selected by short press or long press (hold) the button. Pushing a button for 2+ second is considered "long press" (hold).

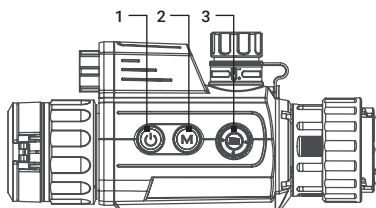

FIGURE 2-2. NEITH DC CONTROLS

TABLE 2-1. NEITH DC CONTROLS

ITEM	CONTROLS	FUNCTIONS
1	POWER BUTTON	Press: Standby mode / Wake up device. Hold: Power ON/OFF.
2	MODE BUTTON	Hold: Switch display modes.
3	OPERATION WHEEL	Press: Start/stop recording. Hold: Menu operation. Rotate: Menu navigation.
2 + 3	MODE BUTTON + WHEEL BUTTON	Press two buttons simultaneously: Image capture.

2.1.4 POWER ON AND OFF



Power On

When the battery is enough, hold the POWER button (⏻) for about 2 seconds to power on the device. Refer to the figure 2-3 for the main view of the display.

Power Off

When the device is turned on, hold the POWER button (⏻) to power off the device.

NOTE

See the battery icon on the device display for the electricity quantity. Icon  means the battery is fully charged, and icon  means that the battery is low.

When the low power note shows, charge the battery.

Auto Power Off

In the "Auto Power Off" menu you can set the time for the automatic shutdown of the device as required (OFF / 30 min / 45 min).

The Auto Power Off function starts countdown when Standby mode enable. The auto power off countdown is disabled when the device wakes up from standby. The countdown will be restarted when the device is put into standby mode again.

2.1.5 STANDBY MODE

Standby mode is used to save battery power. In the view mode, press the POWER button (⏻). After a few seconds, the display will turn off. Press the POWER button (⏻) again to exit the Standby mode.

2.1.6 OBSERVATION

1. Install the Neith TC on the weapon with a day scope (refer to part 2.1.15 or 2.1.16). Verify that the clip-on is securely mounted.
2. Remove the protective caps.
3. Point the equipment at an object.
4. Activate the Neith TC.
5. If the day scope includes a focusing ring (i.e., parallax adjustment knob), adjust the focus for a parallax-free image.
6. Turn on the day scope's reticle illumination and adjust the reticle brightness.
7. Adjust the focus of Neith TC by turning the focus ring.
8. Configure the Rattler TC for your specific situation. Set display mode, brightness, contrast to display the best image effect.

For more information on operational setting procedures, see Part 2.2 (Main Functions).

2.1.7 ON-SCREEN DISPLAY (OSD)

On-screen interface displays the main setup menu items and device status indicators. Refer to the Figure 2-3 for the main view of the display.

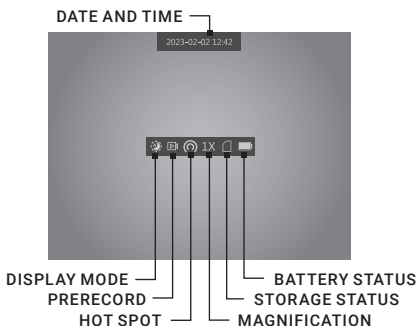

FIGURE 2-3. ON-SCREEN DISPLAY

Hold the wheel button (⌂) in the view mode to display or hide the menu.

In the OSD (On-Screen Display) menu you can choose which information to display in the live view interface.





When OSD is on, the information of display mode, prerecord video activation, Wi-Fi hotspot activation, magnification, storage memory status, battery status, time and date can be displayed on the screen.

2.1.8 SET DISPLAY MODE

You can select different display modes in different scenes.

Hold MODE button (M) in live view interface to switch display modes. Day, Night, Defog, and Auto are selectable. The current mode is displayed on the right top of the display interface.

TABLE 2-2. DISPLAY MODE

SYMBOL	MODE	DESCRIPTION
	Day	Full-color image for daytime.
	Night	Black & white viewing at night.
	Auto	Allows to optimize the image in various lighting conditions.
	Defog	Increases ability to detect IR information in fog.

2.1.9 IR ILLUMINATOR

In the Night and Auto display modes, the device works with the built-in IR illuminator when there is insufficient natural light.

The Auto mode determines the illumination of the environment in real time. In extremely low light or in complete darkness, the system will automatically turn on the built-in infrared lighting, and when the ambient light increases, the system will automatically turn off the IR illumination.

Before using the device at night, remove the protective cover from the IR illuminator. Rotate the IR focus ring to adjust the IR beam spread.

2.1.10 VIDEO RECORDING AND IMAGE CAPTURE

Video Recording

In the live view interface, press the wheel button (⊖) to start recording, and press the wheel again to stop recording.

Image Capture

In the live view interface press the MODE button (M) and wheel button (⊖) at the same time to capture the image.

NOTE:

- When capturing, the image freezes for 1 second and a prompt shows on the display.
- For exporting captured pictures, refer to Files Export.

2.1.11 CONNECTING THE DEVICE

1. Open the USB interface cover.
2. Connect the device and power supply with a USB cable to external power the device. Alternatively, connect the device and PC with a USB cable to copy/delete files.

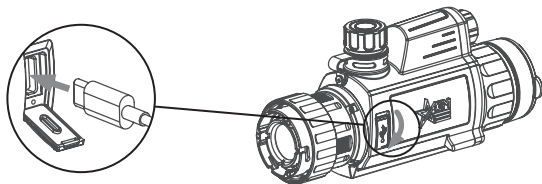

FIGURE 2-4. TYPE-C USB INTERFACE

2.1.12 FILE EXPORT

1. Connect the rifle scope to your PC with USB cable and open the detected disk.
2. Open computer disk and select the disk of device. Go to the DCIM folder and find the folder named after the capture year and month. For example, if you capture a picture or record a video on January 2023, go to DCIM -> 202301 to find the picture or video.
 - Select and copy the videos to PC and play the file with the player.
 - Select and copy the snapshots to PC and view the files.
3. Disconnect the device from your PC.

NOTE:

- The device displays images when you connect it to PC. But functions such as recording, capturing and hot spot are disabled.
- When you connect the device to PC for the first time, it installs the drive program automatically.

2.1.13 INSTALLING THE CLIP-ON ONTO THE LENS OF A DAY SCOPE

WARNING:

Always make sure your firearm is unloaded before you place the scope on the firearm. Reconfirm that the chamber is empty if you stop the procedure then resume later. Safe firearms handling rules should be followed at all times.

Use the front adapter to install the Neith DC onto day scope lenses.

NOTE:

The Neith DC cannot be attached to scopes that include focus rings on the housing of the objective lens.

NOTE:

The adapter must fit with the diameter of the day scope front lens. There are various optional day scope front adapters available for a wide range of objective lens diameters.

Install the optional Front Q-R adapter to the Neith DC as follows (refer to Figure 2-5):

1. Align the pins of the reducing ring (A) with the bayonet grooves in the Neith DC output lens attachment place. This position is marked with a red dot on the ring and output lens.

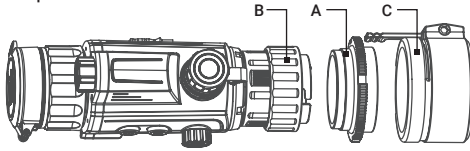

FIGURE 2-5. FRONT Q-R ADAPTER INSTALLATION

2. Insert the reducing ring to the grooves and then turn it clockwise as far as it will go.
3. Rotate the Neith DC's fixing ring (B) clockwise to tighten it on the reducing ring thread. Please note the fixing ring has left-hand thread. Be careful not to overtighten the fixing ring.
4. Screw the front adapter (C) into the reducing ring.

NOTE:

Different models of front adapters may have different designs. Refer to the user manual for your adapter for correct installation.

Install the Neith DC on the lens of a day scope as follows (refer to Figure 2-6):

1. Turn the lever (A) of adapter (B) backwards to loosen the adapter clamping device.
2. Slide the Neith DC with the adapter onto the lens of the day scope (C) as far as it goes.
3. Affix the clip-on to the day scope by locking the lever (A) of adapter.
4. Rotate the clip-on to align its vertical position. Tighten the lock nut (D) tightly with the special wrench to secure the position.
5. Verify that the clip-on is firmly secured to the day scope.

NOTE:

AGM recommends that you use an eyecup on the day scope's eyepiece for maximum safety and comfort, as well as to escape detection.

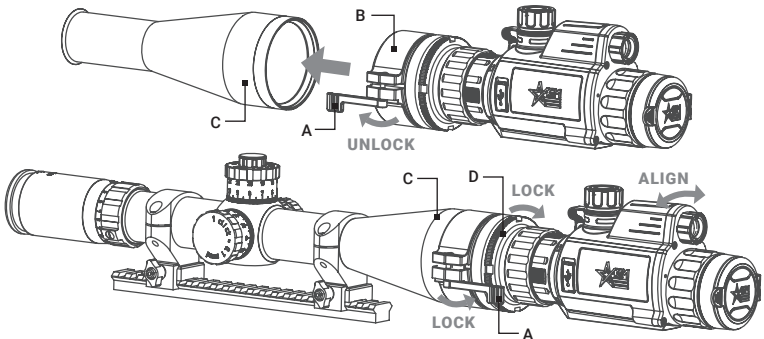

FIGURE 2-6. CLIP-ON INSTALLATION

2.1.14 INSTALLING THE NEITH DC ON A PICATINNY/WEAVER RAIL

WARNING:

Always make sure your firearm is unloaded before you place the scope on the firearm. Reconfirm that the chamber is empty if you stop the procedure then resume later. Safe firearms handling rules should be followed at all times.

A Picatinny/Weaver mount is secured to the Neith DC with two screws. The recommended tightening torque for the fixing screws is 4-5.3 Nm (5.44-7.2 ft lb).

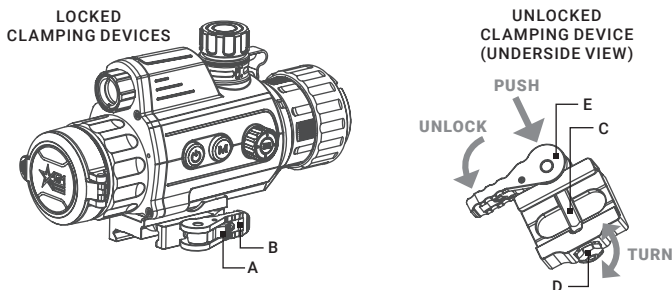

FIGURE 2-7. MOUNT

To install the Neith DC on a Picatinny/Weaver rail, perform the following:

1. Unlock the clamping device of the scope mount by pushing down on the lever holder (A) and unlocking the lever (B).
2. Install the scope on the Picatinny/ Weaver rail so that the stop (C) slides into the transverse slot on the rail.
3. Affix the scope to the rail by locking the lever (B).
4. Verify that the clamping device is firmly holding the Neith DC. If necessary, adjust the clamping device's lever-cam lock as detailed in part 2.1.15.

2.1.15 CLAMPING DEVICE ADJUSTMENT

To adjust the mount's clamping device, do the following:

1. Remove the Neith DC from the weapon.
2. With the clamping device unlocked (as shown in Figure 2-7), push the cam (E) towards the arrow, which will cause the nut (D) to slide out of its hole.
3. To tighten/ loosen the clamping device, push down on the cam (E) and turn the nut (D) CW/ CCW respectively, in one-two increments (see note below). Much like when the cam (E) is released, backward-moving spring will cause the nut (D) to slide back into its hole.

NOTE:



The eight-sided nut of the mount lever-cam lock will only fit into their hole if turned in one of the discrete positions, using increments equal to $360^\circ/8$.

4. Verify that the adjusted lever-cam lock securely holds the weapon mounting rail.

2.2 MAIN FUNCTIONS

2.2.1 MENU OPERATION

When the device is turned on, hold the wheel button  to display the menu.

Rotate the operation wheel to move between menu items. The active element is highlighted in orange. Press the wheel button  to select menu item or change an option. Hold the wheel button  to exit the menu.

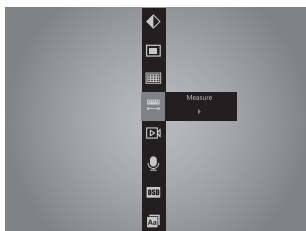

























FIGURE 2-8. THE MAIN MENU

TABLE 2-3. MENU FUNCTION

MENU ITEM	SYMBOL	OPTION	FUNCTION
BRIGHTNESS		10 Levels of brightness	Adjusts the image brightness.
CONTRAST		10 Levels of contrast	Adjusts the image contrast.
SMART IR		ON	Helps correct overexposed images, and can also improve the image in night mode.
		OFF	
CALIBRATE IMAGE		Reference Line ON / OFF	Helps to solve the problem of shooting deviation and to achieve better accuracy.
MEASURE		Target: Deer, Grey Wolf, Brown Bear, and Custom	Measures the distance between the target and the observation position.
PRERECORD		OFF / 7s / 10s / 15s (seconds)	Shot Activated Recording (SAR). The device can automatically start video recording the 7, 10 or 15 seconds before and after the recoil-activation.
AUDIO		ON	Enables or disables audio recording.
		OFF	
OSD		ON	Enables or disables OSD, time, date.
		OFF	





MENU ITEM	SYMBOL	OPTION	FUNCTION
LANGUAGE		20 Languages	Choice of interface language.
TIME SYNC.		24-Hour Time / Time / Date	Setting the time and date.
AUTO POWER OFF		OFF / 30 min / 45 min	Setting the automatic shutdown time.
UNIT		yard / m	Sets the distance unit.
RESTORE		---	Restoring the default device settings.
VERSION		---	Firmware version and serial number.
NETWORK		Close	Enables or disables the Wi-Fi hotspot.
		Hotspot	

2.2.2 BRIGHTNESS ADJUSTMENT

1. Hold the wheel button  to go to the menu.
2. Rotate the wheel to select  **Brightness** menu item and press the wheel button  to adjust the brightness.
3. Turn the wheel to move to another menu item or hold the wheel  button to exit a menu.

You can select one of ten levels of the brightness to adjust the image lighter or darker.





2.2.3 CONTRAST ADJUSTMENT

1. Hold the wheel button  to go to the menu.
2. Rotate the wheel to select  **Contrast** menu item and press the wheel button  to adjust the image contrast.
3. Turn the wheel to move to another menu item or hold the wheel  button to exit a menu.

You can select one of ten levels of the contrast.



2.2.4 SMART IR

Image overexposure may occur in too bright environment. The Smart IR function helps to adjust the overexposed images, and it can improve the image effect in night mode by adjusting the brightness of the supplement light.

1. Hold the wheel button  to go to the menu.
Hold the wheel button  to go to the menu,
2. Rotate the wheel to select  **Smart IR** menu item and press the wheel button  to enable or disable this function.
3. Turn the wheel to move to another menu item or hold the wheel  button to exit a menu.

2.2.5 CALIBRATE IMAGE

After mounting of clip-on to the weapon with day scope the clip-on optical axis can be offset off scope optical axis. The Image Calibration function supports manually adjusting the position of the live preview window by enter the coordinates of image window. The image region could be adjusted in 4 directions in the whole screen area. This way the device can adjust the view to make it consistent with the optical view.

1. Aim your day scope to the middle of target and shoot. This action will test the control of day scope accuracy.
2. Mount the clip-on to the day scope. Aim at the center of the target and shoot again.
1. Hold the wheel button  to show the menu.
2. Rotate the wheel to select **Calibrate Image** menu item and press the wheel button  to confirm.
3. Rotate the wheel to select the coordinates, and press the wheel button  to switch the X and Y axis. Rotate the wheel to move the image. The changed coordinates will be displayed.

One step of image calibration means 0.11 mil / 0.37 MOA / 1.1 cm at 100 m distance / 0.37 in at 100 yd distance.

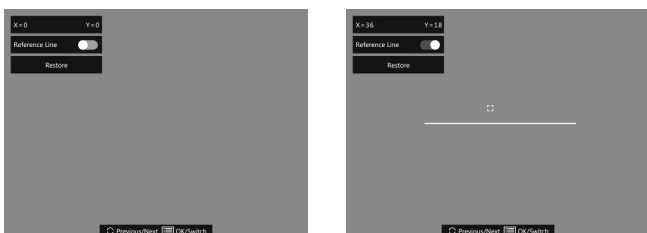





FIGURE 2-9. IMAGE CALIBRATION EFFECT WITH THE REFERENCE LINE

4. (Optional) Rotate the wheel to select **Reference Line**, and press the wheel button  to enable this function. A horizontal reference line appears in the middle of the view when it is enabled.
5. (Optional) Rotate the wheel to select **Restore**, and press the wheel button  to confirm. Select **OK** to restore the view to default position, and **CANCEL** to return to the setting interface.

NOTE:

The default position of image window may not be exactly at zero (X=0, Y=0). This is caused by slight individual differences of optical components, and it is a normal phenomenon.

6. Hold the wheel button  to save position and exit image calibration.

For example:









When the point of impact with Neith DC is 5 cm on the right side and 7.5 cm on the up side of previous point of impact (previous aiming position), move the image to the right (the X value will increase by 5), and move the image up (the Y value will decrease by 7).

2.2.6 DISTANCE MEASUREMENT

The device can measure the distance between the target and the observer's position.

NOTE:

When measuring the distance, keep the hand and the position steady. Otherwise, the accuracy may be affected.

1. Hold the wheel button  to show the menu.
2. Rotate the wheel to select  Measure and press the wheel button  to go to the setting interface.
 - 1) Rotate the wheel to select the target from Deer, Grey Wolf, Brown Bear, and Custom.
 - 2) Press the wheel button  and rotate the wheel it to set the target height. Each target height preset can be modified from 0.1 to 9.9 m.
 - 3) Press the wheel button  to confirm.
3. Hold the wheel button  to return to the distance measurement interface.
4. Align the center of the top mark with the top edge of the target. Press the wheel button . The top mark blinks and then changes to the bottom mark.
5. Align the center of the bottom mark with the bottom edge of the target. Press the wheel button . The bottom mark blinks and then disappears.

The left top of the image displays the distance measurement result and the height of the target.







FIGURE 2-10. DISTANCE MEASUREMENT

NOTE:

Go to distance measurement interface, and press the wheel button  to view the result of the previous measuring target.

2.2.7 PRERECORD VIDEO

After you enable this function and select the prerecording time, the device can automatically start recording the 7, 10 or 15 seconds before the recoil-activation and end recording the 7, 10 or 15 seconds after the recoil-activation.





1. Hold the wheel button  to show the menu.
2. Rotate the wheel to select  Prerecord menu item.
3. Press the wheel button  to switch the prerecording time. 7s, 10s, 15s and OFF are selectable.
4. Turn the wheel to move to another menu item or hold the wheel  button to exit a menu.

NOTE:

If you activate recoils continuously, the device will start recording the 7, 10 or 15 seconds before the first recoil and end recording the 7, 10, or 15 seconds after the last recoil.







2.2.9 SET AUDIO

If you enable the audio function, the sound will be recorded with the video. When there is too loud noise in the video, you can disable this function.

1. Hold the wheel button  to show the menu.
2. Rotate the wheel to select  **Audio** menu item.
3. Press the wheel button  to enable or disable this function.
4. Turn the wheel to move to another menu item or hold the wheel  button to exit a menu.





2.2.10 ON-SCREEN DISPLAY (OSD)

You can choose which OSD information to display in the live view interface.

1. Hold the wheel button  to show the menu.
2. Select  **OSD** menu item and press  button to enter.
3. Press the wheel button  to select the **OSD, Time** or **Date**. Press  button to switch on/off mode and confirm.
4. Hold the wheel  button to exit OSD menu.







2.2.11 LANGUAGE SETTING

You can select different languages of user interface.

1. Hold the wheel button  to show the menu.
2. Rotate the wheel to select  **Language** menu item and press the wheel button  to enter.
3. Rotate the wheel to select the language as required, and press the wheel button  to confirm.





2.2.12 TIME SYNCHRONIZATION

You can display the date and time on the screen. 24-hour and 12-hour time format are available.





1. Hold the wheel button  to show the menu.
2. Rotate the wheel to select  **Time Sync**. menu and press  button to enter the time and date settings menu.
3. Rotate the wheel to select the **24-Hour Time** and press the wheel button  to switch the time format.
4. Rotate the wheel to select the **Time** or **Date**. Press the wheel button  to select the hour, minute, second, year, month, or day to be synchronized, and rotate the wheel to change the number. Press the wheel button  again to confirm.
5. Hold the wheel button  to save settings and exit.

2.2.13 AUTO POWER OFF

You can set the time for the automatic shutdown of the device as required.



1. Hold the wheel button  to show the menu.
2. Rotate the wheel to select  **Auto Power Off** menu item and press the wheel button  to select OFF, 30 min or 45 min.
3. Turn the wheel to move to another menu item or hold the wheel  button to exit a menu.

2.2.14 UNIT

1. Hold the wheel button  to show the menu.
2. Select  **Unit** and press the wheel button  to switch the distance measurement unit .
3. Turn the wheel to move to another menu item or hold the wheel  button to exit a menu.





2.2.15 RESTORE DEVICE

You can reset the settings of device.

1. Hold the wheel button  to show the menu of device.
2. Select  **Restore** menu item and press the wheel button . The window "Initialize?" will appear.
 - **OK**: Restore the device to defaults.
 - **CANCEL**: Exit without changing the settings.





2.2.16 VIEW DEVICE INFORMATION

You can view the device information such as firmware version, and serial number.

1. Hold the wheel button  to show the menu.
2. Select  **Version** menu item and press the wheel button . The firmware version, and serial number will be displayed on the screen.
3. Turn the wheel to move to another menu item or hold the wheel  button to exit a menu.

2.2.17 NETWORK

Connect your phone to the Wi-Fi hotspot of the clip-on, you can configure the parameters and realize functions of the device.

1. Hold the wheel button  to show the menu.
2. Select  **Hotspot** menu item and press the wheel button  to enable or disable Wi-Fi hotspot.
3. Turn the wheel to move to another menu item or hold the wheel  button to exit a menu.
4. Open the AGM Connect APP and connect your phone with the device (refer to Section 2.3). You can view the interface of rifle scope on your phone.

NOTE:

When the power is less than 15%, the Wi-Fi hotspot function will be turned off automatically.

2.3 CLIENT SOFTWARE INTRODUCTION

Search the AGM Connect software in App Store (iOS System) or Google Play™ (Android System) and install the application on your mobile phone. Turn on the Wi-Fi hotspot on the digital scope and then connect your phone to the hotspot.



- Hotspot Name: Wlan-<Serial No.>

- Hotspot Password: Last 9 digits of Serial Number of your digital scope.

NOTE:

The device password is set by user at first activation. If the password was lost or forgotten, it can be reset. To reset a password perform the following steps:

1. When the rifle scope is turned on, hold the wheel button  to activate the OSD menu.

2. Select  menu item and press the wheel button  to restore all parameters to default settings.

1. Run the app and connect the phone or tablet with the device.

2. If the device is inactivated, set the password and activate it. If the device is activated, enter the password to add it to the app.

3. When the device is added, the live view can be seen. You can view the interface of the device on the software. User can change such image parameters as brightness, contrast, zoom, palettes directly via phone or tablet as well as record video on phone/tablet memory.

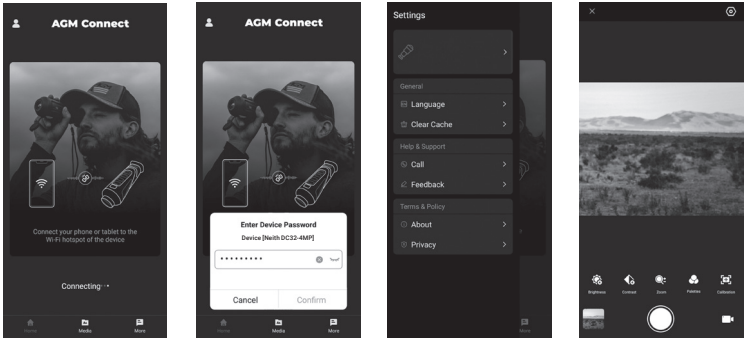

FIGURE 2-11. CLIENT SOFTWARE

3 MAINTENANCE

3.1 MAINTENANCE

3.1.1 CLEANING PROCEDURES

1. Gently brush off any dirt from the body of the device using a clean, soft cloth.
2. Moisten the cloth with fresh water and gently wipe down the external surfaces (except lenses).
3. Dry any wet surfaces (except lenses) using another dry, clean, soft cloth.
4. Using a lens brush, carefully remove all loose dirt from the lenses.
5. Dampen a cotton swab with ethanol and slowly, gently wipe down the lenses. Clean the glass surfaces using circular movements, starting from the center of the lens and moving out towards the edge, without touching the lens holder. Change the cotton swab after each circular stroke. Repeat this step until the glass surfaces are clean.
6. Clean the accessories with a soft brush (or cloth) dampened with soap and water.

3.1.2 PREPARING FOR EXTENDED STORAGE

CAUTION:

Thoroughly dry each item before placing them into the storage case.

To prepare the monocular for extended storage:

1. Clean the monocular and accessories.
2. Place all items into the storage case.
3. Make sure to remove the battery from the unit.

3.1.3 UPDATING THE DEVICE FIRMWARE

1. Visit www.agmglobalvision.com/firmware website. Select your product, download the firmware update package to your PC and unzip it. Follow the detailed instructions on the website.
2. Connect the device to your PC with USB cable.
3. Turn on the device. Make sure the Wi-Fi hotspot function is disabled.
4. Open the detected disk (USB drive) in file manager program. Copy the unzipped digicap.dav file and paste it to the root directory of the device.
5. Turn off the device completely, then power it back on. After awhile, the firmware update process will start automatically. During the update, the screen will display the inscription "Upgrading...". The update process will be completed when the inscription "Upgrading..." goes out.

6. Repeat steps 4-5 for each updating file.
7. Turn off the device and disconnect it from your PC.

You can also enjoy automatic update function in AGM Connect App (see section 2.3 for details).

1. Start the AGM Connect App and tap the Settings icon in the left top corner.
2. Tap your device in the device list. The information about your device will shown.
3. Tap **Checking for Upgrade** to detect and download the latest FW version.

3.2 TROUBLESHOOTING

Table 3-1 lists the most common malfunctions that may occur with your equipment. Perform the tests, inspections, and corrective actions in the order they appear in the table.

This table does not list all the malfunctions that may occur with your device, or all of the tests, inspections, and corrective actions that may be necessary to fix them. If the equipment malfunction is not corrected by the suggested actions, or a problem occurs that is not listed in this table, please contact AGM Global Vision's Customer Support center or your retailer.

TABLE 3-1. TROUBLESHOOTING

MALFUNCTION	CORRECTIVE ACTION
The clip-on fails to activate.	<ol style="list-style-type: none"> 1. Battery is missing or improperly installed. Insert battery or install correctly. 2. Battery is dead. Replace the battery. 3. Battery, surfaces or contacts are dirty or corroded. Clean the contact.
Device power indicator is off.	Examine whether the device is off-battery.
The image of the clip-on is not clear.	Perform the clip-on adjustment referring to section 2.1.
Wi-Fi is not found.	Examine whether the Wi-Fi function is turned on. If not, go to OSD menu and turn on Wi-Fi.
Image capture or video recording fails.	Examine the items below: <ol style="list-style-type: none"> 1. Whether the device is connected to your PC and disabled the capture and recording. 2. Whether the storage space is full. 3. Whether the device is low-battery.
The PC cannot identify the clip-on.	Examine the items below: <ol style="list-style-type: none"> 1. Whether the device is connected to your PC with standard USB cable. 2. If you use other USB cables, make sure the cable length is no longer than 1 m.

4 WARRANTY INFORMATION

4.1 WARRANTY INFORMATION AND REGISTRATION

4.1.1 WARRANTY INFORMATION

This product is guaranteed to be free from manufacturing defects in material and workmanship under normal use for a period of three (3) years from the date of purchase. In the event that a defect covered by the warranty below occurs during the applicable period stated above, AGM Global Vision, at its discretion, will either repair or replace the product; such action on the part of AGM Global Vision shall be the full extent of AGM Global Vision's liability, and the Customer's sole and exclusive reparation. This warranty does not cover a product if it has been (a) used in ways other than its normal and customary manner; (b) subjected to misuse; (c) subjected to alterations, modifications or repairs by the Customer or by any party other than AGM Global Vision without prior written consent of AGM Global Vision; (d) is the result of a special order or categorized as "close-out" merchandise or merchandise sold "as-is" by either AGM Global Vision or the AGM Global Vision dealer; or (e) merchandise that has been discontinued by the manufacturer and either parts or replacement units are not available due to reasons beyond the control of AGM Global Vision. AGM Global Vision shall not be responsible for any defects or damage that in AGM Global Vision's view are a result from the mishandling, abuse, misuse, improper storage or improper operation of the device, including use in conjunction with equipment that is electrically or mechanically incompatible with, or of inferior quality to, the product, as well as failure to maintain the environmental conditions specified by the manufacturer. This warranty is extended only to the original purchaser. Any breach of this warranty shall be enforced unless the customer notifies AGM Global Vision at the address noted below within the applicable warranty period.

The customer understands and agrees that except for the foregoing warranty, no other warranties written or oral, statutory, expressed or implied, including any implied warranty of merchantability or fitness for a particular purpose, shall apply to the product. All such implied warranties are hereby and expressly disclaimed.

4.1.2 LIMITATION OF LIABILITY

AGM Global Vision will not be liable for any claims, actions, suits, proceedings, costs, expenses, damages, or liabilities arising out of the use of this product. Operation and use of the product are the sole responsibility of the Customer. AGM Global Vision's sole undertaking is limited to providing the products and services outlined herein in accordance with the terms and conditions of this Agreement. The provision of products sold and services performed by AGM Global Vision to the Customer shall not be interpreted, construed, or regarded, either expressly or implied, as being for the benefit of or creating any obligation toward any third party of legal entity outside AGM Global Vision and the Customer; AGM Global Vision's obligations under this Agreement extend

solely to the Customer. AGM Global Vision's liability hereunder for damages, regardless of the form or action, shall not exceed the fees or other charges paid to AGM Global Vision by the customer or customer's dealer. AGM Global Vision shall not, in any event, be liable for special, indirect, incidental, or consequential damages, including, but not limited to, lost income, lost revenue, or lost profit, whether such damages were foreseeable or not at the time of purchase, and whether or not such damages arise out of a breach of warranty, a breach of agreement, negligence, strict liability, or any other theory of liability.

4.1.3 PRODUCT REGISTRATION

In order to validate the warranty on your product, the customer must complete and submit AGM Global Vision PRODUCT REGISTRATION FORM on our website (www.agmglobalvision.com/customer-support).

4.1.4 OBTAINING WARRANTY SERVICE

To obtain warranty service on your unit, the End-user (Customer) must notify the AGM Global Vision service department via e-mail. Send any requests to support@agmglobalvision.com to receive a Return Merchandise Authorization number (RMA). When returning any device, please take the product to your retailer, or send the product, postage paid and with a copy of your sales receipt, to AGM Global Vision's service center at the address listed above. All merchandise must be fully insured with the correct postage; AGM Global Vision will not be responsible for improper postage or merchandise that becomes lost or damaged during shipment. When sending product back, please clearly write the RMA# on the outside of the shipping box. Please include a letter that indicates your RMA#, the Customer's Name, a Return Address, reason for the return, contact information (valid telephone numbers and/or an e-mail address), and proof of purchase that will help us to establish the valid start date of the warranty. Product merchandise returns that do not have an RMA# listed may be refused, or a significant delay in processing may occur. Estimated Warranty service time is 10-20 business days. The End-user/Customer is responsible for postage to AGM Global Vision for warranty service. AGM Global Vision will cover return postage/shipping after warranty repair to the End-user/Customer only if the product is covered by the aforementioned warranty. AGM Global Vision will return the product after warranty service by domestic UPS Ground service and/or domestic mail. Should any other requested, required, or international shipping methods be necessary, the postage/shipping fee will be the responsibility of the End-user/Customer.

For service, repair or replacement, please contact:

AGM Global Vision, LLC

173 West Main Street

PO Box 962

Springerville, AZ 85938

Tel. 928.333.4300

support@agmglobalvision.com

www.agmglobalvision.com

5 SPECIFICATIONS

5.1 SPECIFICATIONS

MAIN	
Max. Resolution	2560 × 1440
Frame Rate	25 Hz
Magnification	1×
Lens System	32 mm; F1.2
Field of View	9.9° × 7.5°
Minimal Focusing Distance	3 m
Detection Range	400 m (with IR ON)
Display	0.49" OLED display, 1920×1080, 50 FPS
Exit Pupil	22 mm
Eye Relief	10 mm
SYSTEM	
Image Mode	Day, Night, Auto, Defog
Video Recording	Yes (2560×1440, MP4)
Audio Recording	Yes
Shot-Activated Recording	Yes
Image Capture	Yes (2560×1440, JPEG)
Storage	Built-in EMMC (64 GB)
Standby Mode	Yes
Freeze Zeroing	Yes
Wi-Fi Hotspot	Yes
POWER SUPPLY	
Battery Type	One 18650 Rechargeable Li-Ion battery
Battery Operating Time	5.5 hours continuous running (@ 25°C, Hotspot, IR Emitter OFF)
Over Voltage Protection	Yes
External Power Supply	5 VDC/2 A, USB Type-C interface

GENERAL	
Working Temperature	-30°C to 55°C (-22°F to 131°F)
Max. Recoil	750 g
Dimensions	183 × 70 × 87 mm (7.2 × 2.7 × 3.4 in)
Weight	0.57 kg (1.25 lb) without battery
Protection Level	IP67

**All data is subject to change without notice.*

NOTES

A series of horizontal dotted lines for taking notes.



AGM Global Vision, LLC

MAIN OFFICE

173 West Main Street

PO Box 962

Springerville, AZ 85938

USA

Tel. +1.928.333.4300

info@agmglobalvision.com

www.agmglobalvision.com

EUROPEAN OFFICE

#6 Andrey Lyapchev Blvd

Sofia, P.C. 1756

Bulgaria

Tel. +35.988.560.0326

info@agmglobalvision.eu

www.agmglobalvision.eu

DOWNLOAD AGM CONNECT APP:



Google Play Store



Apple App Store

AGMglobalvision.com